



Digital Door Lock

User Guide YDR4110



YDR4110

INTRO

Thank you for choosing a YALE product.

We welcome you to this new door solution world of YALE that is the leading brand in the world digital door lock industry.

Please find comfort and security in yourself through perfectly combined digital and analog technologies presented by YALE .

This user manual enables you to operate the product more convenient and safer.

Be sure to read this completely before using it.



CONTENTS

Getting Started

Safety Cautions	4
Product Features	5
Quick Instruction	6

Directions

Components Overview	8
Identification	9
How to Use	10
Password	
Fingerprint Guide	
Normal Mode: Use Fingerprint	
Security Mode: Use Fingerprint	
Remove Fingerprint	
Lock Door	
Open Door from Inside	
Settings	17
Manual Lock Mode Alarm • Volume	
Auto / Manual Locking • Voice / Melody	
Fingerprint Mode Change	
Forced Lock	
Safety Feature	21
Alarm Function	
3-minute Lock • Open Door with fake PIN code	

Extra Features

Option	24
Remote Control Module	
Remote Control	
Emergency Power	26
Specifications	27

Safety Cautions

Must Read This!!!

Please read this carefully for your own safety.

Do not install the unit in outdoor environment.



Do not attempt to disassemble the unit by yourself. That can cause an electronic shock and product damage.



An infant and some users who have unusual fingerprints (those which are difficult to register) may not be registered for fingerprint verification.



※ Scan-type fingerprint modules do not recognize fingerprints with water or foreign materials.

Do not use force with a tool onto the product.



Please keep your Password safely.



Make sure to lock the door tight when you go out.



Do not spray water directly to the product or wipe it with chemical substances such as benzene, thinner, or alcohol when cleaning the product.



Keep foreign materials away from the fingerprint sensor to maintain it cleanly and do not use it with wet fingers.

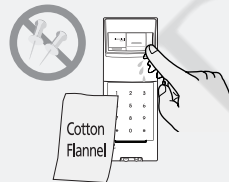

Caution

Make sure to follow the above instructions to avoid any injuries or damages on the properties .

Product Features

1 One-touch Fingerprint Verification Method (Easy Scan)

Easy Scan technology has been applied to conveniently read a fingerprint in one shot without the need to open or close the cover to enter a fingerprint.

2 Smart Pad Feature

A separate lighting method where each keypad number has been separately designed is applied so that users may examine intuitively how the selected function is operated and if they are run normally.

3 Verification with the palm

The security code is verified by palm touching to randomize any fingerprint residues on the keypad so protect from exposing it.

4 Voice Guide Feature

As the voice guide is offered that lets you know the operation status and how to set each feature and mode for easier and more convenient use.

5 Networking System (Option)

You can use the remote control by installing the applicable remote control module. This option may not be available depending on your country or local dealer.

Quick Instruction

1 Register Password

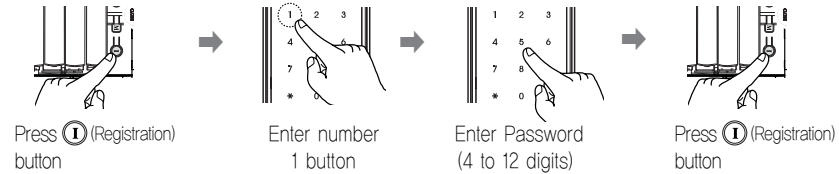

5 Register Fingerprints

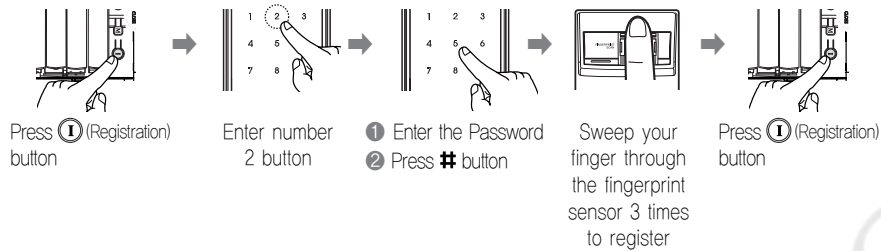

3 Locking the Door from the outside

- ① The automatic Lock Sensor detects the door closing and locks the door within 5 seconds, or
- ② Touch the keypad with the palm

4 Unlocking the Door from the outside

- ① Sweep a registered fingerprint through the fingerprint sensor, or
- ② Wake up the lock with the palm touch, enter the security code and retouch the lock with the palm.

5 Locking / Unlocking the Door from the inside

- ① Press open / close Button

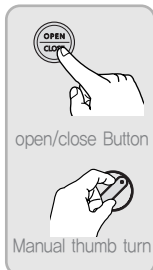

- ② Turn the Manual thumb turn to lock / unlock

6 Set Auto/ Manual Lock Mode

Be the Auto/Manual Lock Setting button released in the back body to set Auto



Be the Auto/Manual Lock Setting button pressed in the back body to set Manual

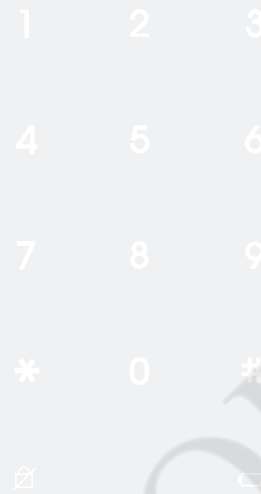

Directions

Components Overview	8
Identification	9
How to Use	10
Password	
Fingerprint Guide	
Normal Mode: Use Fingerprint	
Security Mode: Use Fingerprint	
Remove Fingerprint	
Lock Door	
Open Door from Inside	
Settings	17
Manual Lock Mode Alarm • Volume	
Auto / Manual Locking • Voice / Melody	
Fingerprint Mode Change	
Forced Lock	
Safety Feature	21
Alarm Function	
3-minute Lock • Open Door with fake PIN code	

Components Overview

Basic Contents

The contents of this product may be subject to change without notice for performance or quality improvement.

Basic Contents

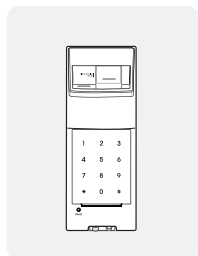

Front (Front Body)



Back (Main Body)

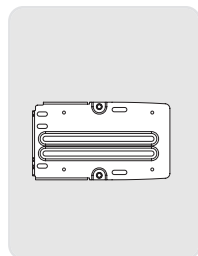

Main Bracket

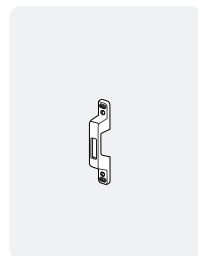

Strike



Users Guide

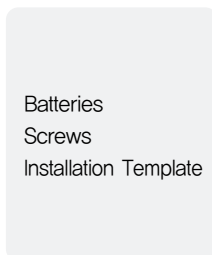

Batteries
Screws
Installation Template

Option

- Remote control
- Remote control module

Identification

Front

(Front Body, install on the outside of the door)

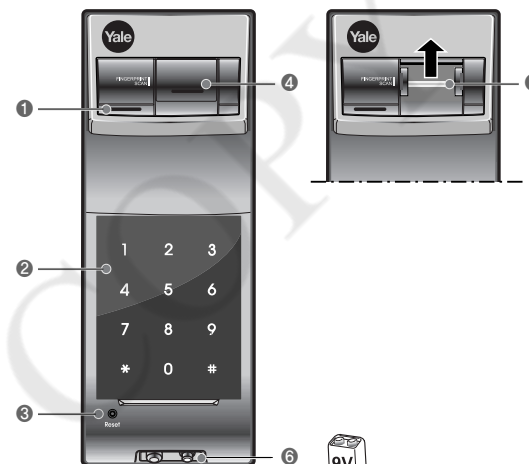

1	Fingerprint Operation Lamp
2	Keypad (10-Key)
3	Reset button
4	Fingerprint Cover
5	Fingerprint Sensor
6	Emergency Power Supply Terminal



9V Emergency battery
(Optional)

Back

(Back Body, install on the inside of the door)

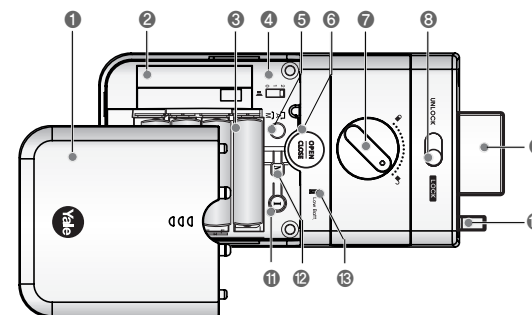



1	Battery Cover
2	Remote Control Module Slot (Option)
3	1.5V AA Alkaline Batteries
4	Volume Control Switch
5	Auto / Manual Lock Button
6	Open / Close button
7	Manual Thumb Turn
8	Forced Lock Switch
9	Dead Bolt
10	Edge Bolt (Auto Lock Sensor)
11	ⓘ Registration Button
12	Ⓜ Menu Button
13	Low Battery Indicator

How to Use



To Use Password

Passwords should be selected from 6 to 12 digits, [*] and [#] are not allowed.

>> To Register Password

Order	Play	Description
1 Press ① (Registration) button		Open the battery cover in the back body and press ① (Registration) button once.
2 Press number 1 button → Enter the Password		Press the number 1 button and then the Password on the keypad according to the voice guide. (4 to 12 digits)
3 Press ① (Registration) button		Press the ① (Registration) button in the back body again to complete the Password registration.

>> To Open Door with Password

Order	Play	Description
1 Touch with palm		Touch the keypad of the front body gently with your palm.
2 Enter Password		Enter the registered Password in the exterior number plate.
3 Touch with palm		Touch the keypad of the front body gently with your palm or press [*] button to end.

Note

- Make sure to leave the door open when registering a Password because you may accidentally lock a door while trying to register or change a Password the first time.
- The previously registered Password will automatically be deleted when the new Password is registered.
- When registering a Password, the registered Password will be displayed on the keypad (Smart Pad) in sequential order and, then, be disappeared.

How to Use

Fingerprint

>> Fingerprint Guide

To change modes: Please refer to page 19.

Normal Mode : It enables you to make individual registration, and open a door through the registered fingerprint or Password.

Security Mode : It enables you to make individual registration and deletion, and open a door only when the fingerprint number and the fingerprint match.

Operations

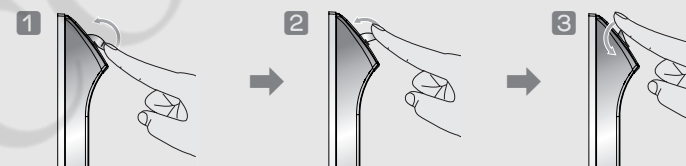

Press and lift up the Guide Bar on the fingerprint cover.

You will see the fingerprint cover being raised and start to open.

Open the cover completely

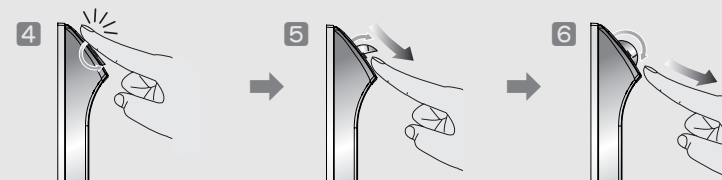

When the fingerprint cover is completely open, the lamp will be on.

Start sweeping your fingerprint through the sensor.

Complete your fingerprint recognition.

Note











- You may register up to 20 fingerprints. (The same applies to Normal/Security Mode)
 - ※ Note that you may not register 20 fingerprints depending on the state of the registered fingerprints.
- Scan-type fingerprint modules do not recognize fingerprints with water or foreign materials.
- Make sure to register a Password just for the case you fail to register a fingerprint.
- Make sure to leave the door open when registering a Password because you may accidentally lock a door while trying to register or change a Password the first time.
- If an error occurs during registration, the process reverts back the beginning (entering fingerprint).
- If no more input is made for 20 seconds after registering at least 1 fingerprint, the registration is completed.
- Same fingerprints can be registered repeatedly.

How to Use



Normal Mode: Use Fingerprint

It enables you to make individual registration, and open a door through the registered fingerprint or Password.

>> To Register Fingerprint

Order	Play	Description
1 Press  (Registration) button		Open the battery cover in the back body and press  (Registration) button once.
2 Press number 2 button → Enter the Password → Enter  button		Press the number 2 button according to the voice guide. Press the Password and then the  button on the keypad.
3 Register fingerprint – 3 times		After the operation lamp is on, sweep your fingerprint 3 times through the fingerprint sensor according to the voice guide.
4 Press  (Registration) button		Press the  (Registration) button in the back body again to complete the fingerprint registration. (Press  button to continue the additional fingerprint registration.)

>> To Open Door with Fingerprint

Order	Play	Description
1 Lift the fingerprint cover open		Lift open the fingerprint cover and wait for the operation lamp to light on.
2 Enter fingerprint		Sweep the registered fingerprint through the fingerprint sensor in the front body.

Check if a door opens!

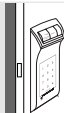









Make sure to examine if the door opens normally with the registered Password or fingerprint after the registration is complete.

How to Use



Security Mode: Use Fingerprint Please refer to the page 19 to change the mode

It enables you to make individual registration and deletion, and open a door only when the fingerprint number and the fingerprint match.

>> To Register Fingerprint

Order	Play	Description
1 Press  (Registration) button		Open the battery cover in the back body and press  (Registration) button once.
2 Press number 2 button → Enter the Password → Enter  button		Press the number 2 button according to the voice guide. Press the Password and then the  button on the keypad.
3 Press fingerprint number		Enter 4-digit fingerprint number to register.
4 Register fingerprint – 3 times		After the operation lamp is on, sweep your fingerprint 3 times through the fingerprint sensor according to the voice guide
5 Press  (Registration) button		Press the  (Registration) button in the back body again to complete the fingerprint registration. (Press  button to continue the fingerprint registration process.)

>> To Open Door with Fingerprint







Order	Play	Description
1 Touch with palm		Touch the keypad of the front body gently with your palm.
2 Press fingerprint number		Enter the registered fingerprint number in the keypad.
3 Enter fingerprint		Sweep the registered fingerprint through the exterior fingerprint sensor.

How to Use









Remove Fingerprint

You may only delete each fingerprint separately in the Security Mode.

» To Delete All Fingerprints

Order	Play	Description
1 Press  (Registration) button		Open the battery cover in the back body and press  (Registration) button once.
2 Press number 3 button ➔ Enter the Password		Press the number 3 according to the voice guide and then, the Password on the keypad.
3 Press  (Registration) button		Press the  (Registration) button in the back body again to delete all fingerprints.



» To Delete Each Fingerprint (Security Mode)

Order	Play	Description
1 Press  (Registration) button		Open the battery cover in the back body and press  (Registration) button once.
2 Press number 4 button ➔ Enter the Password ➔ Enter the #		Press the number 4 according to the voice guide and then, the Password and [#] on the keypad.
3 Registered fingerprint number		Enter the fingerprint number to delete on the keypad.
4 Press  (Registration) button		Press the  (Registration) button in the back body again to delete a single fingerprint.



How to Use

Lock Door

» To Close Door from Outside

Order	Play	Description
Auto Lock status		The built-in Auto Lock sensor automatically locks a door within 5 seconds after closing the door.
Manual Lock status		Touch the keypad in the front body gently with your palm to lock a door.

» To Close Door from Inside

Order	Play	Description
Auto Lock status		The built-in Auto Lock sensor automatically locks a door within 5 seconds after closing the door.
Manual Lock status		Turn the Manual thumb turn to Close side to lock a door.
		Press Open/Close button

Note

- Even after a door was locked by the Auto Lock function, please check again if the door was completely closed and locked.

How to Use

Open Door from Inside

➤ Press Open/Close button

Press Open/Close button

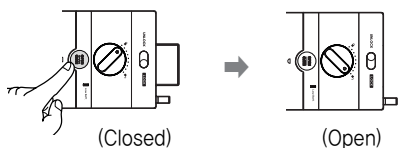

➤ Using Manual thumb turn in Emergency

Turn manual thumb turn to
Unlock to open the lock.

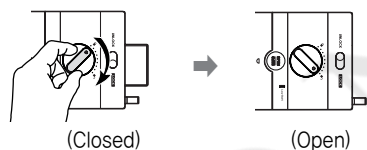

Settings

Manual Lock Mode Alarm

In the default setting, manual lock mode does not ring off the alarm when it unlocked by manual thumb turn.
However, the users can change it for their own security need.

➤ Toggling the Manual Lock Mode Alarm Setting

Order	Play	Description
1 Press M button		Press M Button inside of battery cover
2 Press 0, 8 button		Press 0, 8 button on the keypad
3 Press M button		Press M Button inside of battery cover to change the setting

Volume Setting

It enables you adjust the volume of various sounds from the product.

➤ Volume Setting

Order	Play	Description
To set volume switch		The operation sound loudness is adjusted according to the Volume Switch Setting. (2 : Louder / 1 : Lower / 0 : Mute)

Note



- Even when the operation sound is set as 'Mute,' the error and alarm sounds will go off.

Settings

Automatic / Manual Lock Setting

Auto Lock setting locks a door within 5 seconds after the door is closed.

> To Set Auto/Manual Feature

Order	Play	Description
Auto Lock Setting		Be the back body Auto/Manual Setting button released to set Auto
Manual Lock Setting		Be the back body Auto/Manual Setting button pressed to set Manual

Voice / Melody Feature

You may select the operation sound that is set off when a door is open and closed.

> To Set Voice/Melody Feature

Order	Play	Description
1 Press M button		Press M Button inside of battery cover
2 Press 2, 2 button		Enter the number 2 and then, 2 again on the keypad.
3 Press M button		Press M Button inside of battery cover to change the setting

Note





- Even after a door was locked by the Auto Lock function, please check again if the door was completely locked.

Settings

Fingerprint Mode Change

The default setting is Normal Mode.

> Fingerprint Mode Setting

Order	Play	Description
1 Press M button		Press M Button inside of battery cover
Security Mode Setting Press number 1 and 1 button → Enter the Password		Press the number 1 and then, 1 again on the keypad. Enter the registered Password.
Normal Mode Setting Press number 1 and 3 button → Enter the Password		Press the number 1 and then, 3 again on the keypad. Enter the registered Password.
2 Press M button		Press M Button inside of battery cover to change the setting



Note

- It is advised to keep the fingerprint exclusive number(4 digits) as a separate list just in case for a separate fingerprint deletion at Security Mode.
- If more than 1 fingerprint is registered after the Security Mode is set, you may not open a door only with a Password. (If the fingerprint module is broken, you may use a Password.)



Settings

Forced Lock

» Outside Forced Lock Setting – Fingerprint

Order	Play	Description
1 Enter fingerprint		Enter the registered fingerprint on the fingerprint sensor when the operation lamp(LED) is on.
2 Press # button for 5 seconds		Press the [#] button for 5 seconds. (A beeping sound sets off for 3 times.)

» Outside Forced Lock Setting – Password

Order	Play	Description
1 Touch with palm		Touch the keypad of the front body gently with your palm.
2 Enter Password		Enter the registered Password in the exterior number plate.
3 Press # button for 5 seconds		Press the [#] button for 5 seconds. (A beeping sound sets off for 3 times.)

» Inside Forced Lock Setting

Order	Play	Description
Set / Release Inside Forced Lock Switch		When the door is closed, move the Inside Forced Lock Switch to LOCK position so that a red sticker can be seen.

Note

- If you try to open a door with the Manual thumb turn from inside when the Outside Forced Lock is set, the alarm goes off.
- If the Inside Forced Lock is set, any attempt to open a door from outside whether it'd be a fingerprint or a Password won't work.
- When setting the Outside/Inside Forced Lock, enter the number on the keypad (Smart Pad) and the numbers will flicker from left to right and repeat twice.

Safety Feature

Alarm Feature

The alarm sound continues for 30 minutes or until it is disarmed.

» Break-in / Damage Alarm

Break-in: When someone tries to Break-in by opening a door when it is locked, the alarm will go off.

Damage: When the front body was damaged due to forced separation or drilling, the alarm will go off.



Release Trespass/Damage Alarm

- Method 1** Enter the registered Password.
Method 2 Enter the registered Fingerprint.
Method 3 Press the interior ① button for 5 seconds.

» High Temperature Alarm

• When there's fire, it detects the temperature of the inside. It not only goes off an alarm but also releases the lock status automatically.

• Even when the Inside Forced Lock mode is set, the High Temperature Alarm releases the lock status automatically.



Release High Temperature Alarm

- Method 1** Enter the registered Password.
Method 2 Enter the registered Fingerprint.
Method 3 Press the interior ① button for 5 seconds.

Note

- If a door is open when the Auto Lock is not properly operated, the Trespass Alarm might go off.
- If the Back body is exposed to direct sunlight for a long time, the temperature sensor may operate and go off an alarm.
- Even when the Inside Forced Lock mode is set, the lock status will automatically be released if the High Temperature Alarm goes off.
- If the alarm goes off due to damage, fire, or trespass, the numbers on the keypad will light up clockwise. (It repeats the status for 30 minutes with alarm sound.)

Safety Feature

3-minute Lock Feature

At 3-minute Lock mode, no button, besides those in the back body, will work.

>> 3-minute Lock Mode Display

- If a Password or a Fingerprint that is yet to be registered is entered for 5 consecutive times, 3-minute Lock mode is on and nothing will work for 3 minutes.

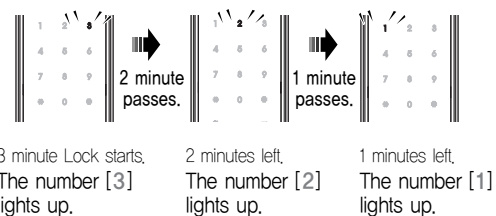

To Release 3-minute Lock

Method ① Press the Open/Close button.

Method ② Press the Back body ① button.

Open Door with fake Password

It is the most effective feature when you are concerned about your Password being accidentally exposed when you have company or in the similar situations.

>> To Open Door with fake Password

Order	Play	Description
① Touch with a palm		Touch the keypad with your palm gently.
② Enter the fake Password and a Password		Method ① Enter the fake Password → Password Method ② Enter the Password → fake Password
③ Touch with a palm		Touch the keypad with your palm gently or press [*] button to end.

Note

- 3-minute Lock mode won't affect any alarm and is sustained even after the product is rebooted.
- Once 3-minute Lock mode is on, the fake Password mode won't work until the next normal verification (Fingerprint verification, normal Password, open door from inside). In this case, please open a door with your correct Password.

Extra Features

Option	24
Remote Control Module	
Remote Control	
Emergency Power	26
Specifications	27



Option

Remote Control Module

Buy the Remote control Module and install it to link the remote control.

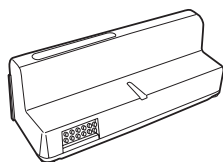

Remote control Module

Install Remote Control Module

1 Remove batteries

Open the battery cover in the back body and remove all batteries.

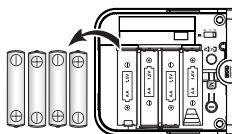

2 Install Remote Control Module

Equip the Remote control Module to the slot.

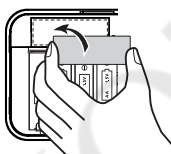

3 Insert batteries

Insert all the batteries by checking the (+, -) connector.

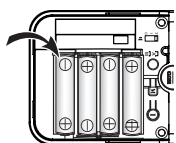

4 Confirm the installation

If you hear a 'ting-a-ling' sound, the Remote control Module has been installed correctly. Close the battery cover.

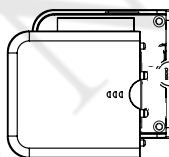

Ting-a-ling

Note

- The operation status may only be examined through the remote control.

Option

Remote Control(Optional)

Not only FSK method but also the wireless encryption algorithm has been applied.

To Register Remote Control

Order	Play	Description
1 Press M button		Open the battery cover in the back body. Press M button.
2 Enter number 0 and 5 on the keypad		Enter the number 0 and then, 5 button on the keypad.
3 Register Remote Control		Press the SET button of the remote control
4 Press M button		Press the M button in the back body again to complete the procedure.

To Release Remote Control

Order	Play	Description
1 Press M button		Open the battery cover in the back body. Press M button.
2 Enter number 7, 5 on the keypad		Enter the number 7, 5 on the keypad.
4 Press M button		Press the M button in the back body again to complete the procedure.

Note





- The wireless encryption algorithm resorts to the floating ID technology where the wireless Password is changed every time the remote control is operated.

Emergency Power

Emergency Power Supply for Discharged Batteries

You may open a door by contacting the 9V battery

» To Supply Emergency Power

Order	Play	Description
1 Contact the 9V battery		Open the emergency cover. Keep contacting the 9V battery onto the emergency power supply terminal.
2 Touch with palm		Touch the keypad of the front body gently with your palm.
3 Enter the registered Password.		Enter the registered Password.
4 Press * button		Press the * button. (Please maintain the 9V battery contact until the motor activation is completed)

» To Replace Battery

1 Expiry Period

The product uses four 1.5V(LR6) alkaline AA batteries.
They may sustain 1 year if used 10 times a day.
(Users are advised to use authentic alkaline batteries.)



2 Low Battery Alarm

You must replace all 4 batteries for the following cases:

- * The Low Battery Lamp on the back body flickers red
- * The voice guide sounds("Low battery")

RISK OF EXPLOSION IF BATTERY IS REPLACED BY AN INCORRECT TYPE. DISPOSE OF USED BATTERIES ACCODING TO THE NATIONAL CODE OR RECYCLING PROGRAM.

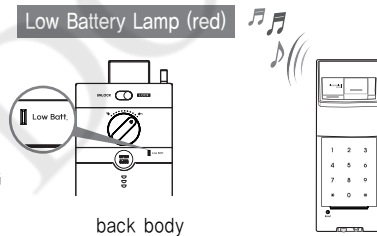

Note

- The battery life varies in the temperature, humidity, the number of use, and the quality of the battery.

Specifications

Specifications

Parts	Specifications	Remarks
Front (Front Body)	19(D)×64.6(W)×160.2(H) Zinc die-casting	Operating temperature : -15~55°C (5~131 °F)
Back (Main Body)	36(D)×85(W)×158(H) Fiber-glass plastic	
Battery	4EA 1.5V AA alkaline batteries (Operating voltage: 4.5 ~ 6 V)	Last up to 1 year (10 times used a day)
Option	Remote Control	Wireless
		Optional

※ Battery life may vary depending on temperature, moisture levels, frequency of use and the quality of the batteries.

※ Please make sure that all parts are included when purchasing the product.

※ Optional products may not be available depending on your country or local dealer.



Note

Note

DO NOT COPY

Note

Note

DO NOT COPY